

**FIELD MOUNTED
RATE TOTALISER
MODEL 102D**



March 2015

CONTENTS

1. Introduction	1
2. Specification	2
3. Operation	4
3.1 Display	4
3.2 Test Mode	5
3.3 Filtering	6
3.4 Calculation of Rate and Total	8
3.5 Total Conversion	9
3.6 Frequency Cutoff	10
4. Programming	11
4.1 Program Steps	12
5. Example	16
6. Power	17
7. Flowmeter Input	18
8. Installation	23
8.1 Wall Mounting	23
8.2 Removing the Front Panel	24
8.3 The Main Electronics	26
8.4 Wiring	27
8.5 Maintenance	27
8.6 Terminal Designations	27
Index	28

1. INTRODUCTION

The Model 102D Rate Totaliser is a microprocessor based instrument which accepts a frequency or pulse input from a wide range of flowmeters. The instrument displays flow Rate, a Resettable Total and an Accumulated Total directly in engineering units.

The instrument is compatible with a wide range of flowmeters including turbine, paddlewheel and positive displacement flowmeters.

The instrument is fully programmable from the front panel; the user can program scaling factors, decimal point positions, filter constants and timebase.

The Model 102D Rate Totaliser conforms to the EMC-Directive of the Council of European Communities 2004/108/EC, the LVD directive 2006/95/EC and the following standards:

EN61326:2013

Electrical equipment for measurement, control and laboratory use – EMC requirements : Residential, Commercial & Light Industry Environment & Industrial Environment.

EN61010:2010

Safety requirements for electrical equipment for measurement, control, and laboratory use.

In order to comply with these standards, the wiring instructions in Section 8.4 must be adhered to

2 Specification

2. SPECIFICATION

General

Display:	LCD which is continuously powered.
Resettable Total:	7 digits with 10mm (0.4") high digits. Resettable from front panel.
Accumulated Total:	Displayed when the ACCUM TOTAL button is pressed.
Rate:	4½ digits with 8.5mm (0.33") high digits.
K-factor:	The pulses per unit of measure (eg. pulses/gallon) is programmable in the range 0.000001 to 999,999.
Decimal Points:	Decimal point positions are fully programmable for both rate and total.
Timebase:	Rate can be displayed in units per second, minute, hour or day.
Frequency Range:	0.01Hz to 10kHz.
Signal Type:	Link settable for sinewave (15mV P-P minimum), open collector, reed switch, pulse or Namur proximity switch.
Supply:	2 x User replaceable Lithium battery. 3.6V, AA types. e.g. TADIRAN SL360/S, SAFT LS14500EX. Note the battery polarity when replacing.
Battery Life:	2 years typical.

Physical

Temperature:	Operating temperature: -20°C to 60°C.
Dimensions:	97mm (3.8") high x 150mm (5.9") wide x 41mm (1.6") deep (cable glands not included).
Protection:	Sealed to Nema 4X or IP67 standards.
Cable Entry:	By cable glands.
Wall Mounting:	Universal mounting bracket supplied as standard.
Pipe Mounting:	A galvanised metal bracket is available which enables the Model 102D to be attached to a 2" vertical or horizontal pipe.
Cutout:	141mm (5.6") wide x 87mm (3.4" high).

4 Operation

3. OPERATION

The Model 102D Rate Totaliser accepts a frequency or pulse input from a wide range of flowmeters. The instrument is fully programmable with all operating parameters and calculation constants programmable from the front panel. The setup parameters are stored in a non-volatile memory and are retained for at least 10 years in the event of a power loss.

3.1 DISPLAY

The Model 102D displays:

Rate
Resettable Total
Accumulated Total

Both the Rate and Resettable Total are displayed continuously. The Accumulated Total is displayed only when the ACCUM TOTAL key is pressed.

The keys on the front of the 102D have the following functions:



Pressing this key will display the Accumulated Total.



This key resets the Resettable Total at any time.



This key is used during the Program Mode.

3.2 TEST MODE

The 102D has a Test Mode which can be entered by simultaneously pressing all 3 front panel keys. The tests are as follows:

<i>Low Test</i>	N/A.
<i>High Test</i>	N/A.
<i>Display Test</i>	By pressing the PROGRAM key, all segments of the display will flash.

To exit Test Mode, all three front panel keys are pressed simultaneously.

6 Operation

3.3 FILTERING

Frequency fluctuations caused by pulsating flow through a flowmeter can interfere with the precision of the rate. For this reason, the Model 102D has a digital filter which will average out these fluctuations and enable accurate readings.

The degree of filtering of the input signal can be adjusted depending on the amount of fluctuation and the particular application. Values from 1 to 99 can be programmed *where 1 corresponds to no filtering and 99 corresponds to heavy filtering*. Such flexibility in filtering means that highly accurate and stable readings can be obtained.

When programming the degree of filtering, it is advisable to start with no filtering (the factor equals 1) and gradually increase until a steady reading is obtained. It is important that the filtering is not too heavy because this will cause an overdamped response.

The following graph shows the time to reach 90% and 99% of a new reading for a step change in input signal.

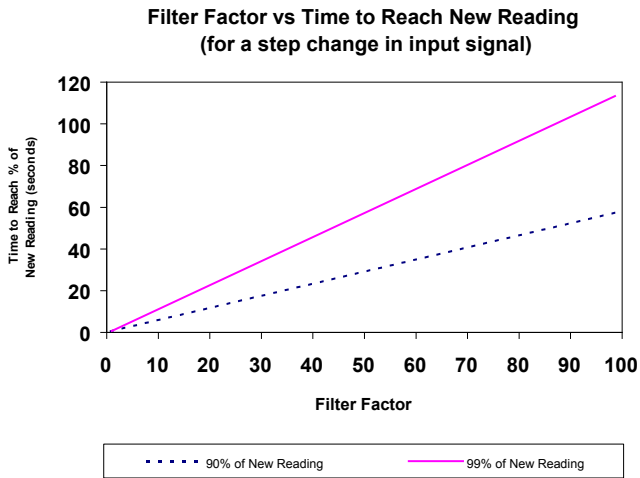

8 Operation

3.4 CALCULATION OF RATE AND TOTAL

The flow rate, R, is calculated as follows:

$$R = \frac{f \times H}{S}$$

where f is the input frequency in Hz (pulses/second).

H is the timebase of rate and is 1 for seconds, 60 for minutes, 3600 for hours and 86,400 for days.

S is the scaling factor (pulses/unit volume).

The scaling factor, S , is equal to the K-factor of the flowmeter expressed in pulses per unit volume. The K-factor is flowmeter dependant and is supplied with the flowmeter. It will be either on a calibration certificate or stamped on the body of the meter.

The user programs the scaling factor and selects the timebase during the programming procedure.

3.5 TOTAL CONVERSION

The Total Conversion Factor is programmed to enable the **rate** to be displayed in one engineering unit and the **totals** to be displayed in another. For example, the rate can be displayed in gallons/minute and the totals in barrels.

The Total Conversion Factor is a division factor which is used to convert the totals to a different unit. Therefore, it only affects the totals (both resettable and accumulated).

Example.

If the Rate is required in gallons/minute:

1. The Scaling Factor would be programmed as pulses per gallon.
2. The Timebase would be programmed as minutes.

If the Totals are required in barrels:

1. The Total Conversion Factor is programmed as 42 because there are 42 gallons in a barrel. All totals will now totalise in barrels.

Below is a table containing common units and their corresponding Total Conversion constants:

<u>Rate/Unit Time</u>	<u>Totals</u>	<u>Total Conversion Factor</u>
Gallons (US)/Unit Time	Barrels (oil)	42.000
Litres/Unit Time	Kilolitres	1000
Litres/Unit Time	m ³	1000
ml/Unit Time	Litres	1000
Mgallons/Unit Time	Acre-feet	0.32587

10 Operation

3.6 FREQUENCY CUTOFF

A frequency cutoff can be programmed below which flow rate is not registered.

Input frequencies at or below the cutoff are totalised, however, the rate is displayed as zero.

The frequency cutoff has a default value of 0.25Hz. The cutoff should be left as 0.25Hz unless the flowmeter in use has a lower frequency.

Note that a low cutoff frequency will result in a correspondingly low response of flow rate update. For example, if the cutoff is set to 0.01Hz the 102D will continue to display the flow rate for 100 seconds even if the signal stops. This is because a cutoff frequency of 0.01Hz means that the time interval between signals is 100 seconds (period = $1/\text{frequency}$). Therefore, the Model 102D must wait 100 seconds before it can determine that the flow has actually stopped.

4. PROGRAMMING

The Model 102D is fully programmable with all parameters being stored in non-volatile memory.

The Program Mode can be entered in one of two ways:

1. By removing the lower cover strip (ie. the dark grey strip along the bottom of the enclosure) and replacing it the wrong side up. This brings a small magnet on the inside of the cover strip in contact with a reed switch inside the instrument.
2. By removing the CAL link, LK4, on the main PCB. Replace the link to exit Program Mode.

The PROGRAM switch is used to step through the program (CAL sequences) and the ► (ACCUM TOTAL) and ▲ (RESET) keys on the front panel are used to change and increment the flashing digits. *Note that only flashing digits can be changed.*

Up to nineteen CAL steps are accessible depending on which options are installed. The CAL number is displayed on the lower display and the parameter is displayed above it.

Parameters in Program Mode that consist of the two parts, **whole numbers** and **digits after the decimal point**, are restricted to having a maximum of 6 significant digits. Therefore the number of significant digits entered in the *whole numbers* determines the number of digits that are able to be entered in the *digits after the decimal point*.

For Example

000001 in the whole numbers makes 00000 available after the decimal place.

000100 in the whole numbers makes 000 available after the decimal place.

010000 in the whole numbers makes 0 available after the decimal place.

12 Programming

4.1 PROGRAM STEPS

Step *Comment*

CAL 0 **N/A**

CAL 1 **Scaling Factor - whole numbers.**

CAL 2 **Scaling Factor - digits after the decimal point.**

The scaling factor is the pulses per unit of measure (eg. pulses/litre, pulses/gallon, etc). The scaling factor can be programmed in the range of 0.000001 - 999,999.

See Section 3.4.

CAL 3 **Cutoff Frequency.**

This determines the cutoff frequency in the range of 0.01 - 0.99Hz. The default setting is 0.25HZ.

Note that care must be taken when programming this value because a low value may cause a slow update time.

CAL 4 **Decimal Point for Rate Display.**

The flow rate can be displayed with 0, 1, 2 or 3 decimal point places.

Step *Comment*

CAL 5 **Timebase for Rate.**

The rate can be displayed in units per second, minute, hour or day.

0 = second

1 = minute

2 = hour

3 = day

CAL 6 **Filter.**

The filter constant for filtering the input signal.

1 No filtering.

to

99 Very heavy filtering.

CAL 7 **Decimal Point for Total Display.**

The totals can be displayed with 0, 1, 2 or 3 decimal points.

CAL 8 **Total Conversion Factor - whole numbers.**

14 Programming

Step *Comment*

CAL 9 **Total Conversion Factor - digits after the decimal point.**

The total conversion factor enables the rate to be displayed in one engineering unit and the totals to be displayed in another engineering unit. The total conversion factor can be programmed in the range of 0.000001 - 999,999.

Set to 1.000 if totals and rate are in the same unit, eg. litres.

See Section 3.5.

CAL 10 **N/A.**

CAL 11 **N/A.**

CAL 12 **N/A.**

CAL 13 **N/A.**

CAL 14 **N/A.**

CAL 15 **N/A.**

CAL 16 **N/A.**

CAL 17 **N/A.**

CAL 18

Enabling and number of points for linearisation

'00' = Linearity Disabled; '02' – '10' number of points

If linearity is enabled by entering a number 02-10, then the programming will request data as per the table below.

Input points are entered in ascending order.

INP 01 Input Frequency '01' whole number

INP ...00 Input Frequency '01' digits after decimal point

OUT 01 Scaling Factor '01' whole number

OUT .00...Scaling Factor '01' digits after decimal point

Repeat the above for the remaining scaling factors.

Any frequency greater than that of the last linearity point will be scaled at the last scaling factor.

SOFT

Software Version.

16 Example

5. EXAMPLE

A flowmeter produces 20.538 pulses per litre and has a maximum output frequency on 200Hz. It is required to display the flow rate in litres/min with 1 decimal point and the total in litres with no decimals.

Calibration mode is entered by removing the lower cover strip (ie. the dark grey strip along the bottom of the enclosure) and replacing it the wrong side up.

The following values are then entered:

<i>Step</i>	<i>Value of Parameter</i>	<i>Description</i>
CAL00	0	No Pulse Output
CAL01	00020	Scaling Factor (whole numbers)
CAL02	5380	Scaling Factor (decimals)
CAL03	0.25	Cutoff Frequency
CAL04	1	Rate decimal position
CAL05	1	Timebase
CAL06	01	Filter disabled
CAL07	0	Total decimal position
CAL08	0001	Total Conversion (set to 1.0000)
CAL09	0000	Total Conversion (decimals)
CAL10	00000	N/A
CAL11	0000	N/A
CAL12	00000	N/A
CAL13	0000	N/A
CAL14	00000	N/A
CAL15	0000	N/A
CAL16	00000	N/A
CAL17	0000	N/A
CAL18	00	Linearity number of points
SOFT	X.XX	Software Version

6. POWER

6.1 BATTERY POWERED

The instrument uses a lithium battery for powering the display. No external power supply is required.

The two Lithium cells are 3.6V, AA types. e.g. TADIRAN SL360/S, SAFT LS14500EX. Note the battery polarity when replacing.

7. FLOWMETER INPUT

The Model 102D has an input conditioning circuit which will accept signals from most **pulse** or **frequency** producing flowmeters. Links on the LCD panel enable the input circuit to be configured for different signal types.

The input will interface directly to:

- ◆ Turbine flowmeters.
- ◆ Open collector outputs.
- ◆ Reed switches.
- ◆ Logic signals.
- ◆ Two-wire proximity switches.

The following pages give examples of interconnection to various signal outputs. A circuit diagram of the input is also provided.

For pulse or logic type signals, the input switching threshold is 1.3 volts. That is, the input signal must have a "low" voltage of less than 1.2 volts and a "high" voltage of greater than 1.4 volts.

For flowmeters with coils, the minimum input voltage is 15mV P-P.

All inputs are protected for over voltage up to 28 volts.

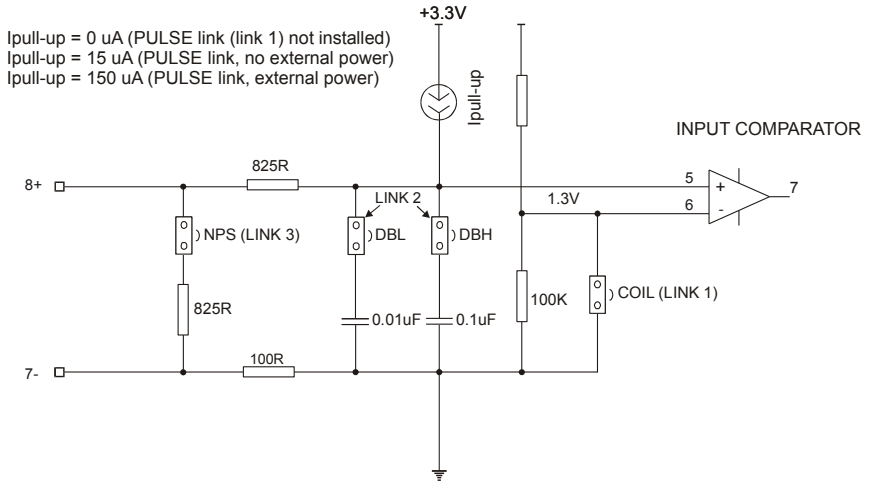

SIMPLIFIED FREQUENCY INPUT CIRCUIT

20 Flowmeter Input

1. Squarewave, CMOS or Pulse

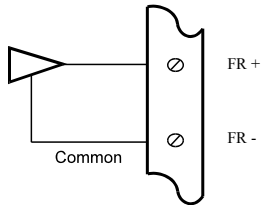

Link Settings

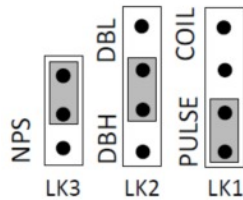

Switching threshold voltage is 1.3

2. Open Collector

With $15\mu\text{A}/150\mu\text{A}$ internal pull up current

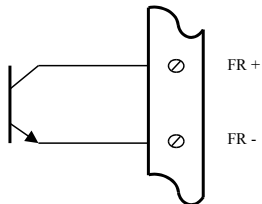

Link Settings

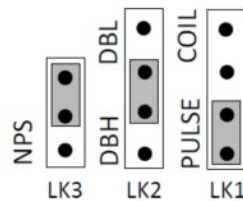

3. Reed Switch - Battery Powered

With $15\mu\text{A}$ internal pull up current

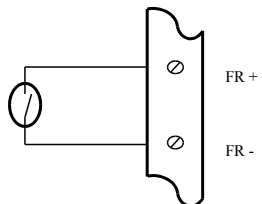

Link Settings

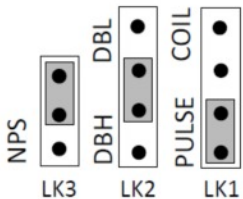

eg. Positive displacement flowmeters with reed switch outputs.

Note: For a switch or reed input with contact bounce link DBL can be switched "on". This will eliminate the effect of switch bounce while limiting the input frequency to 200Hz.

22 Flowmeter Input

4. Reed Switch - External DC Power

With 150 μ A internal pull up current

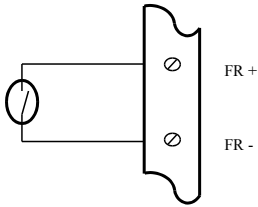

Link Settings

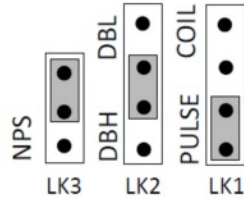

Note: For a switch or reed input with contact bounce link DBH can be switched "on". This will eliminate the effect of switch bounce while limiting the input frequency to 200Hz.

5. Coils

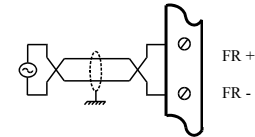

OR

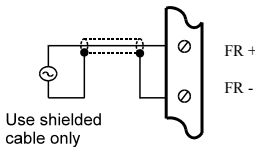

Link Settings

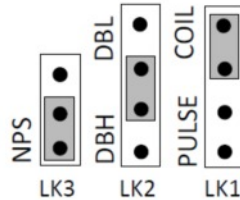

825R input impedance

Note: If the input has a very high impedance, the following link settings should be used:

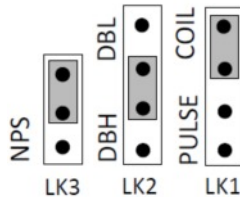

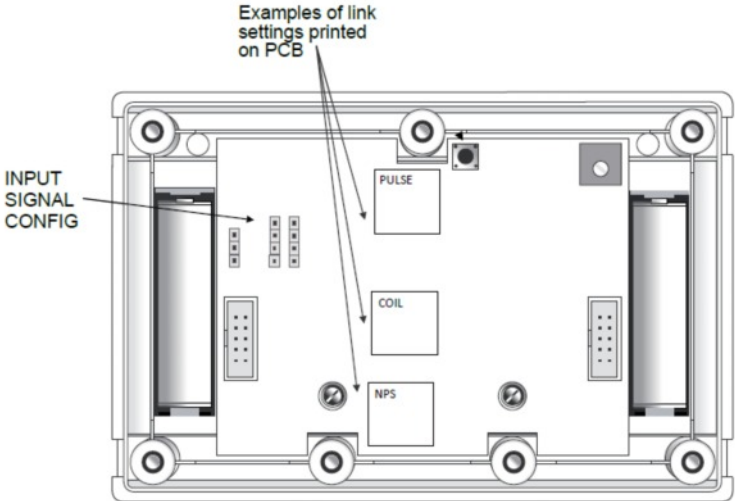

8. INSTALLATION

8.1 WALL MOUNTING

A wall mounting bracket is supplied with each instrument. Round head screws should be used to attach the bracket to the wall (countersunk screws should not be used). The bracket is mounted first with the tray section at the bottom. The instrument is then mounted on the bracket with two screws as shown below.



8.2 REMOVING THE FRONT PANEL

The front panel should be removed as follows:

1. Remove the top and bottom cover strips (ie. the dark plastic strip) by levering a screwdriver under one end.
2. Undo the screws retaining the front. Do not remove the screws, they are retained by O-rings.
3. Remove the front panel from the housing.

To replace the front cover, follow the above procedure in reverse. Ensure that the front panel is aligned at connector points before tightening the screws.



26 Installation

8.3 THE MAIN ELECTRONICS

The front section of the housing contains the microprocessor and display. It is possible to adjust the display contrast via a small potentiometer on the board. The Display Contrast is shown below and this can be adjusted for optimum contrast.

Adjacent to this control is a RESET switch which can be used to reset the microprocessor. *Note that pressing this button will set all totals to zero.*

CAL mode can be accessed by removing the Jumper on Link LK4. Replace jumper to exit CAL mode.

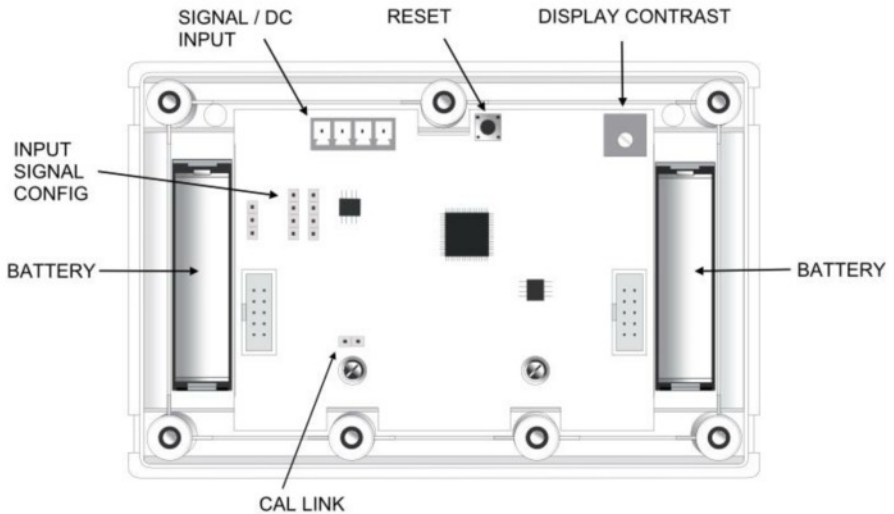

8.4 WIRING

When connecting the 102D it is good practice to use shielded cable. The shield should be connected to earth at one end of the cable. The other end of the shield should not be connected.

This wiring practice is mandatory in order to comply with the requirements for Electromagnetic Compatibility as per EMC-Directive 2014/30/EU of the Council of the European Community.

8.5 MAINTENANCE

All printed circuit boards must be repaired by a Contrec Service Centre

8.6 TERMINAL DESIGNATIONS

J2 - Frequency Input and Optional DC Power.

FR - Pulse (-) / Coil Frequency Input

FR + Pulse (+) / Coil Frequency Input

J5 - Remote Switches.

1	Sw1 (Accum Total)
2	Gnd
3	Sw2 (Reset)
4	Calibration entry
5	Gnd
6	Gnd
7	Sw3 (Program)

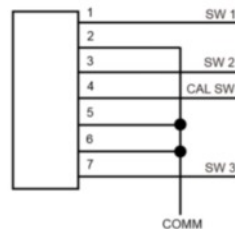

Index

A

Accumulated Total, 2

C

CAL Sequences, 12

Cutoff Frequency, 12

D

Decimal Point, 11, 12

Display, 2, 4

Display Test, 5

F

Filtering, 6

Flow Rate, 8

Frequency Cutoff, 10

I

Input Signal, 19

Installation, 24

M

Model Number, 1

O

Operating

Temperature, 3

Operation, 2

P

Power, 18

Programming, 11

R

Rate, 2

Remote Switches, 27

Removing the Front
Panel, 25

Resettable Total, 2

S

Scaling Factor, 2, 16

Specification, 2

T

Temperature, 3

Terminal

Designations, 28

Test Mode, 5

Timebase, 13

Total Conversion, 9

W

Wall Mounting, 24