

# SP Thermal Flow Switch Operation Manual



## 1.Introduction

The flow switch SP series use thermal dispersion technology to create an accurate and reliable flow sensing device. Two temperature sensors are sealed into a probe, one of which is heated. It exists temperature difference ( $\Delta T$ ) between these two temperature sensors,  $\Delta T$  is inversely proportional to the flow velocity of fluid.

The probe and housing are made of stainless steel with rigid structure and there is no moving parts. There is no wearing problem in this product. Two precision potentiometers used to set the alarm and sensitivity individually. User can set the alarm and sensitivity easily.

## 2.Mounting instruction

When installing SP, please use supplied sealing ring.

- (1).Please assure the minimum distance to the tube bends and intersections greater than four times of pipe diameter. (See Fig. 1)
- (2).Please assure that there is no air bubble in the tube to achieve reliable alarm action. (See Fig. 2).
- (3).When the fluid does not completely fill the pipe, SP must be installed below the pipe. And the fluid level must be higher than the tip of the SP.(See Fig. 3)
- (4).Please assure that SP is mounted tightly to prevent leakage. SP could be mounted on the pipe at any orientation, but the best sensitivity and fastest response will be realized at orientation shown in Fig. 4.
- (5).If there are any particle exists in the fluid, please install a suitable filtering element at the upstream of SP to prevent contamination on the probe of SP.

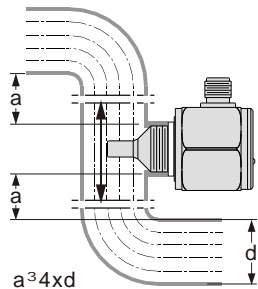

Fig. 1

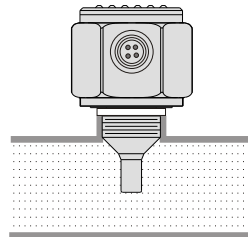

Fig. 2

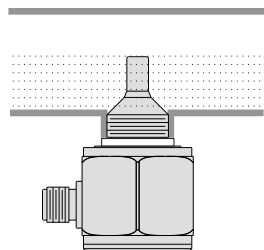

Fig. 3

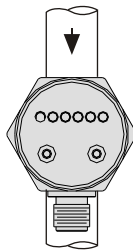

Fig. 4

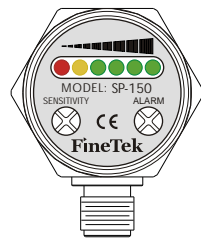

Fig. 5



## 3.Flow monitoring

SP is equipped with 6 LEDs for visual flow velocity monitoring. (See Fig.5)

- (1). Red LED : Flow velocity is below alarm setting.
- (2). Yellow LED: Flow velocity is close to alarm setting.
- (3). Green LEDs(× 4) : Degree of the flow velocity over the alarm setting.

## 4.Alarm setting

- (1). Installing the SP on the flow piping.
- (2). Power ON SP and wait for at least 15 seconds for initial warm up.
- (3). a. For open collector output type : Removing two screws of sensitivity and alarm. (See Fig.5)  
b. For relay output type : Removing the cover
- (4). Adjust the sensitivity setting counter-clockwise to minimum.
- (5). Adjusting the flow velocity to the minimum acceptable level.
- (6). Adjust the alarm setting until yellow LED and three green LEDs lit .

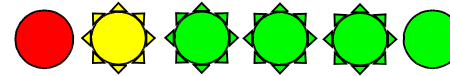

- (7). Slowly adjust alarm setting clockwise until yellow LED and one green LED lit.

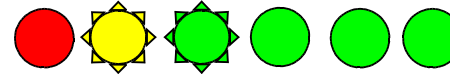

- (8). Slowly decreasing the flow velocity until red LED lit to check the flow velocity of alarm engaged.

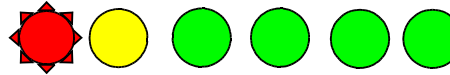

- (9). If the velocity deviation between yellow and red LEDs is too large, then adjust the sensitivity setting clockwise to increase sensitivity. Do step (5),(6),(7) again.
- (10). a. For open collector output type : Putting two screws of sensitivity and alarm back.  
b. For relay output type : Putting the cover back

## 5.Specification

- (1). Flow velocity: 1~150 cm/s (water), 3~300 cm/s(oil)
- (2). Warm-up time: 8 sec. (approximate)
- (3). Operation temperature: -20 ~ 80°C(fluid)
- (4). Operation pressure: 100 bar
- (5). Degree of protection: IP67
- (6). Supply voltage: 24VDC ± 20%
- (7). Output: Open collector---NPN / PNP, 400 mA max. (with current limiting).  
Relay---1A/30VDC, 0.3A/125VAC (NO or NC), 5A/250VAC max. (NO)

## 6.Wiring

### 3-wire

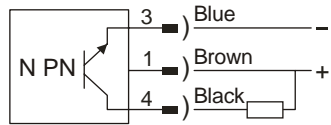

Fig. 6, NPN output type wiring

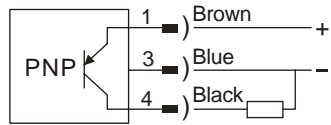

Fig. 7, PNP output type wiring

### 5-wire



Fig. 8, 5A Relay output type wiring

### 4-wire

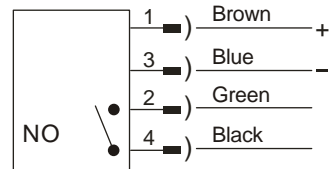

Fig. 9, 1A Relay output type wiring (NO)

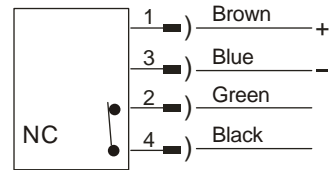

Fig. 10, 1A Relay output type wiring (NC)

### 5-terminal

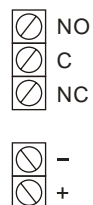

Fig. 11, 5A Relay output type wiring

## 7.Pin assignment

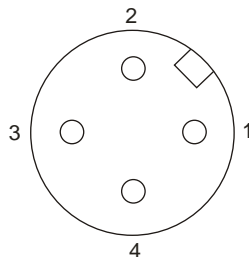

Fig. 12 Front view of connector (NPN & PNP)

## 8.Dimension (G1/2)

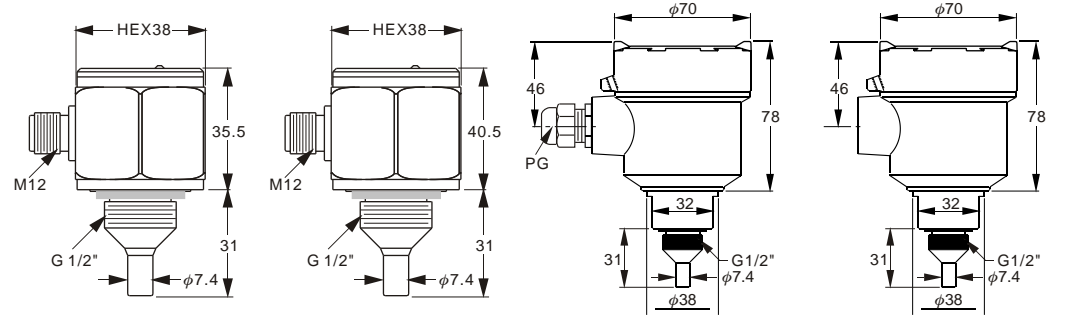

Fig. 13 SP150 (O.C.)

Fig. 14 SP150 1A(Relay)

Fig. 15 SP160 5A(Relay)

Fig. 16 SP170 5A(Relay)

## 9.Maintenance

Under normal operating conditions, no special maintenance is required. Contamination on the probe of SP could change its thermal property. If necessary, using a suitable solvent to clean the surface of the probe periodically.

After cleaning process, re-checking alarm setting and leakage of sealing ring is recommended.

## 10.Warranty

The warranty of SP is described as following:

Period of warranty: 12 months after receiving.

Validation of warranty: The warranty is valid only when the SP150/ SP160 is using under normal operating condition specified in the specifications of SP150/ SP160.

Our warranty: Replace with new SP150/ Sp160 or repairing.

※Subject to change without notice



**FineTek Co., Ltd.**

No.16, Tzuchiang St., Tucheng Industrial Park, Taipei Hsien, Taiwan  
Tel: 886-2-22696789 Fax: 886-2-22686682  
e-mail: info@fine-tek.com http://www.fine-tek.com

