

Flow Monitor

RVP/U

Operation

The flow monitors type RVP/U operate with the float measuring principle



Application

The flow monitors type RVP/U are used for monitoring volumeflow of liquid media.

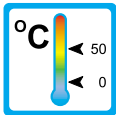

Areas of application:



– Coolingsystems and cooling-circuits

– Mechanical Engineering
e.g. Weldingmachinery,
Laserplants



– Medicine technology

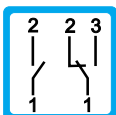

– Research and development

Features

The RVP/U series proves itself through reliable function and easy handling. Further characteristics of this type are:

- universal mounting
- infinitely variable switchpoint adjustment through user
- suitable for distilled or demineralized water
- Threaded connection
Special threads on request

Installation hints

The installation of the flow monitor can be done in any way in the system. The flow direction must be observed.

The flow monitor must not be used as a supporting part in a pipeconstruction!

The medium must not contain any solid particles!
We recommend the installation of strainers type SFD or SFM.

External magnetic fields influence the switch contact. Keep adequate distance to those magnetic fields (e.g. electromotors)!

The operating instruction for RVP/U must be observed under any circumstances!



Measuring Ranges, Technical Data

Connection diagram

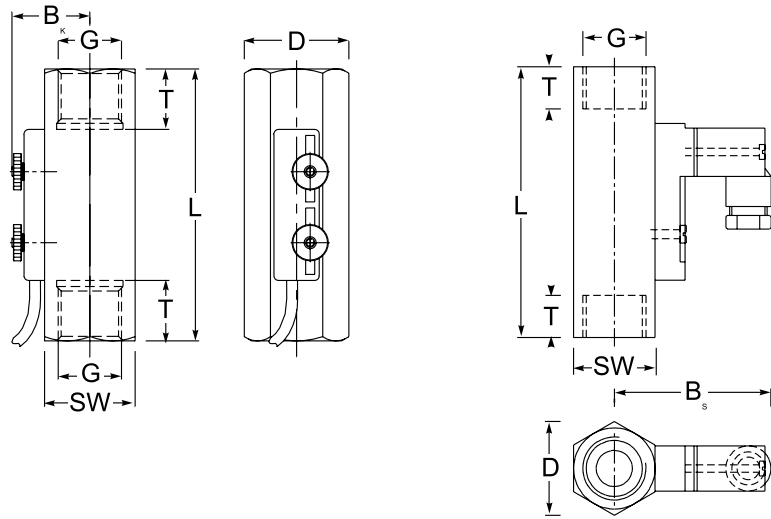
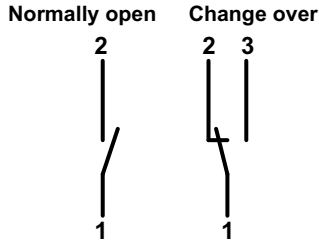

Summary of types RVP/U

Type	Switch range ⁽¹⁾ l/min H ₂ O	Overall dimensions mm							Weight approx. [g]
		SW	D	B _s	B _k	G	T	L	
RVP/U-2/02	0,02 - 0,21	30	34	52	25,8	1/2"	13	90	150
RVP/U-2/06	0,1 - 0,6								
RVP/U-2/1	0,4 - 1,8								
RVP/U-2/3	0,8 - 3,2								
RVP/U-2/7	2 - 7								
RVP/U-2/13	3 - 13								
RVP/U-2/20	4 - 20								
RVP/U-2/30	8 - 30								

(1) Other switch ranges on request

Operating data		RVP/U-2
Operating pressure:		PN 10 bar
Pressure drop:		0,02 - 0,3 bar
Maximum temperature:		50 °C
Accuracy:		10% of full scale
Electrical data:		
Normally open:		max. 230V • 3A • 60VA
Change over:		max. 250V • 1,5A • 50VA ⁽²⁾
Protection type:		IP65 (plug connection DIN 43650 Form C) IP67 (1m sealed in cable)
Output signal:		The contact opens / changes, when the flow falls below the set point.
Power supply:		Not required (potentialfree reed contact)
Other plug types or cable lengths on request		
Material:		
Housing:	(wetted part)	PVC-U (Hard-PVC)
Float:	(wetted part)	1.4571
Magnets:	(wetted part)	Hardferrit
Spring:	(wetted part)	1.4571
Stop rings:	(wetted part)	1.4571

(2) Minimum load 3VA